

Synchrongetriebemotoren - SP-Serie Synchronous Gear Motor - Series SP

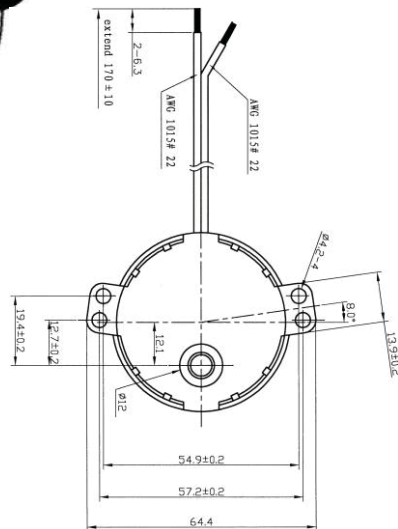

Bestell-Nr. Order no. 230 V 50 Hz	UpM rpm	Dreh- moment torque Ncm	Drehrichtung/Rotating direction r= rechts / l = links cw = clockwise ccw = counter clockwise
210 010 220	1	100	r / cw
210 011 220	1	100	l / ccw
210 250 220	2,5	70	r / cw
210 251 220	2,5	70	l / ccw
211 251 220	2,5	70	l- r / cw - ccw
210 500 220	5	40	r / cw
210 501 220	5	40	l / ccw
900 229	5	40	l- r / cw - ccw
210 100 220	10	25	r / cw
210 101 220	10	25	l / ccw
210 111 220	10	25	r- l / cw - ccw
210 020 220	20	12	r / cw
210 021 220	20	12	l / ccw
211 022 220	20	12	r- l / cw - ccw
210 030 220	30	6	r / cw
210 031 220	30	6	l / ccw
210 131 220	30	6	r- l / cw - ccw

Montagebeispiel:
Motor inklusive Zubehör
Assembling example
Motor incl. accessories

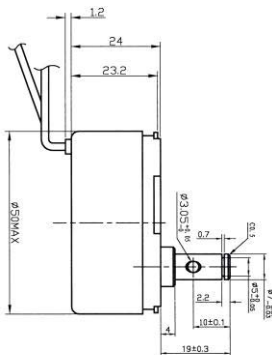
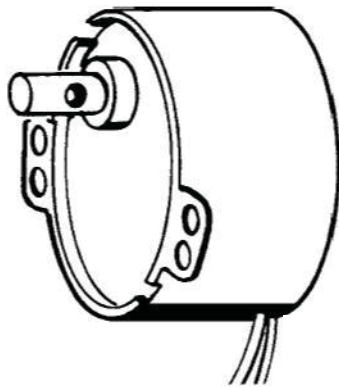
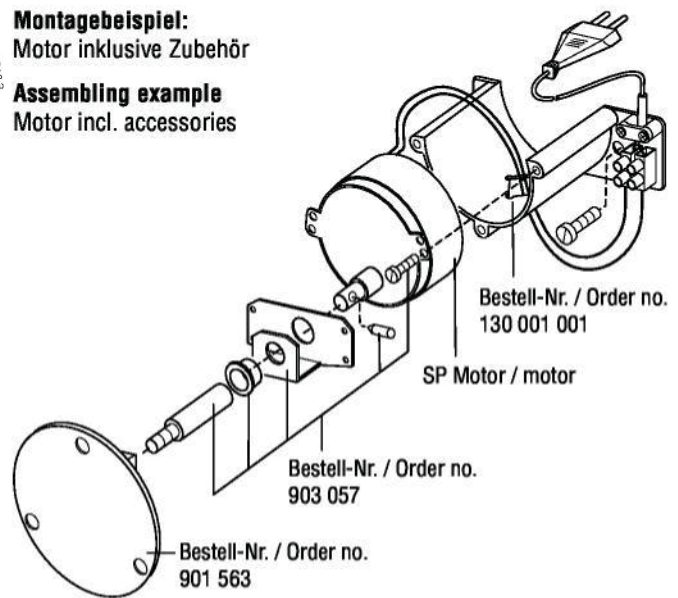

Auch lieferbare Nennspannungen: 6, 12, 24, 42, 115 Volt AC
(Mindestabnahme 500 Stück)

Other available rated voltages : 6, 12, 24, 42, 115 Volt AC
(Minimum order quantity 500 pcs)













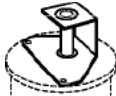

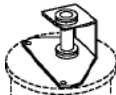

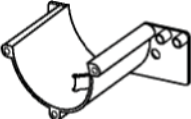

Kundenspezifische Achsen auf Anfrage.
Customized shafts on inquiry.

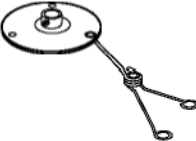
Umfangreiches Standardzubehör auf Wunsch erhältlich.
Extensive standard accessory program available too.

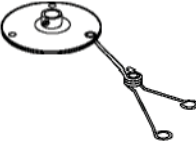
Technische Daten / Technical data

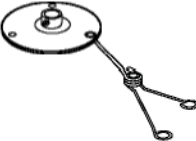
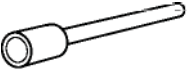
Nennspannung / Voltage	110 - 120 V ~ 220 - 240 V ~	110 - 120 V ~ 220 - 240 V ~	110 - 120 V ~ 220 - 240 V ~	110 - 120 V ~ 220 - 240 V ~	110 - 120 V ~ 220 - 240 V ~	110 - 120 V ~ 220 - 240 V ~
Frequenz / Frequency	60 / 50 Hz	60 / 50 Hz	60 / 50 Hz	60 / 50 Hz	60 / 50 Hz	60 / 50 Hz
Stromaufnahme Rated current	40 / 20 mA	40 / 20 mA	40 / 20 mA	40 / 20 mA	40 / 20 mA	40 / 20 mA
Leistungsaufnahme Rated input	4 W	4 W	4 W	4 W	4 W	4 W
Pol / Pole	10	10	10	10	10	10
UPM ca. / RPM approx.	1 / 1.2	2,5 / 3	5 / 6	10 / 12	20 / 24	30 / 36
Drehrichtung normal Rotating direction normal	Rechts / cw	Rechts / cw	Rechts / cw	Rechts / cw	Rechts / cw	Rechts / cw
Temp. Erhöhung /Temp.rise	< 60 K	< 60 K	< 60 K	< 60 K	< 60 K	< 60 K
Isolationsklasse Insulat. strength	A	A	A	A	A	A
Nennspannungsabweichung Permiss. Volt fluctation	+ / - 15%	+ / - 15%	+ / - 15%	+ / - 15%	+ / - 15%	+ / - 15%
Zul. Umgebungstemperatur Permiss. ambient temperature	-5° bis + 40° C -5° to + 40° C	-5° bis + 40° C -5° to + 40° C	-5° bis + 40° C -5° to + 40° C	-5° bis + 40° C -5° to + 40° C	-5° bis + 40° C -5° to + 40° C	-5° bis + 40° C -5° to + 40° C

Standardzubehör / Standard Accessories

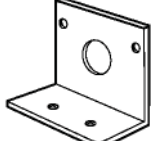
	Flansch Ø 29 mm Bestell-Nr. 901 064	flange Ø 1 ¼ " Order no. 901 064		Stelling für Seilrolle Ø 10 mm Bestell-Nr. Metall 902 279	adjusting nut for sheaves Ø 3/8" Order no. 902 279
	Metallflansch Ø 65mm Bestell-Nr. 901 063	metal flange Ø 2 ½ " Order no. 901 063		Stütz- und Drucklager Bestell-Nr. 903 057	support-bearing Order no. 903 057
	Kunststoffflansch Ø 65 mm Bestell-Nr. 901 563	plastic flange Ø 2 ½ " Order no. 901 563		Stütz- und Drucklager Bestell-Nr. 903 058	support- and thrust bearing Order no. 903 058
	Kupplungsflansch Ø 65 mm Bestell-Nr. 900 150	flange with coupling Ø 2 ½ " Order no. 900 150		Kurbelachse Bestell-Nr. 901 176	crank shaft Order no. 901 176
	Flansch mit Schubstange 65 mm Bestell-Nr. Metall 901 875	flange with crank 2 ½ " Order no. Metal 901 875		Motorfuß, Bestell-Nr. 130 001 001	motor bracket Order no. 130 001 001
	Flansch mit Schubstange 150 mm Bestell-Nr. Metall 901 073	flange with crank 6" Order no. Metal 901 073		Kupplung für 7 mm Achse Bestell-Nr. 901 983	coupling for 7 mm shaft Order no. 901 983
	Flansch mit Schubstange a' 150 mm Bestell-Nr. Kunststoff 901 074	flange with crank a' 6" Order no. Plastic 901 074		Traverse Bestell-Nr. 123 304 001	Suspension bracket Order no. 123 304 001
	Flansch mit Schubstange a' 150 mm Bestell-Nr. Metall 901 190	flange with crank a' 6" Order no. Metal 901 190		Aufsteckachse mit Linksgewinde Bestell-Nr. 900 827	axle with left-handed thread Order no. 900 827
	Flansch mit Schubstange a' 150 mm Bestell-Nr. Kunststoff 901 191	flange with crank a' 6" Order no. Plastic 901 191		Aufsteckachse, Abmessungen auf Anfrage	axle with wire lengthening dimensions on inquiry
	Seilrolle incl. Stelling Ø 50 mm Bestell-Nr. 901 369	rope sheave incl. adj. nut Ø 2" Order no. 901 369		Zahnrad Modul 1, Zähnezahle auf Anfrage	gear wheel, modul 1, no. of teeth on inquiry
	Seilrollenhälfte für Papprohr Ø 50 mm Bestell-Nr. 123 655 000	sheave-set for tube Ø 2" Order no. 123 655 000		Winkel Bestell-Nr. 122 279020	angle bracket Order no. 122 279 020

Technische Änderungen vorbehalten

Subject to technical changes