

LAMB ELECTRIC

PRODUCT DRAWING

MODEL: 114789

DIMENSIONS

NOTES:

- GROUNDING OR EARTHING PROVISIONS: USE HOLES AS INDICATED FOR GROUNDING OR EARTHING. REFER TO APPROPRIATE LISTING OR REGULATORY AGENCY FOR PROPER METHOD OF GROUNDING OR EARTHING.

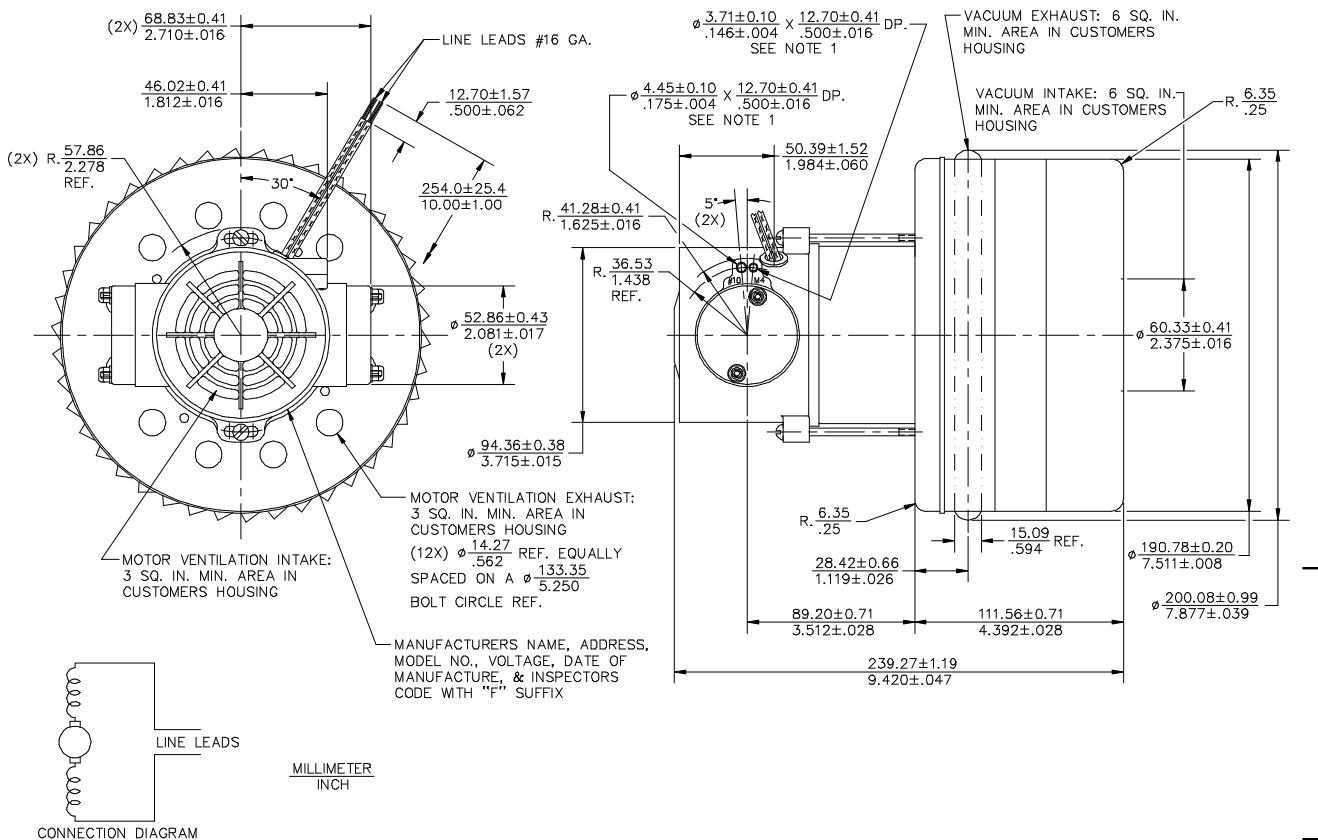

IMPORTANT NOTE: Pictorial and dimensional data are subject to change without notice. Contact factory for current revision levels.